

FLOOR PLAN - KUALA LUMPUR, MALAYSIA

23 & 24 January, 2010 (Sat & Sun)

Mid Valley Exhibition Centre

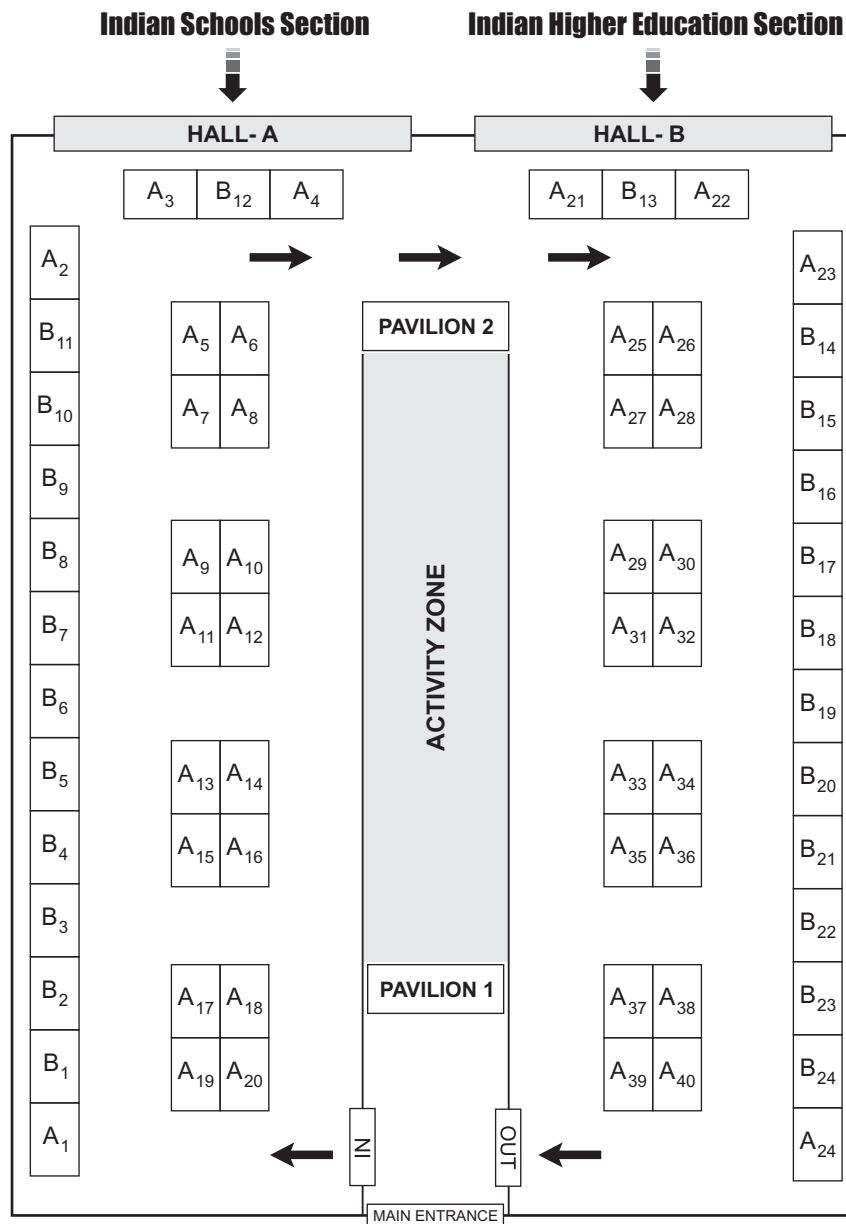

Stall Type	Stall Size	Rate (INR)
A (2 sides open)	3 m x 2 m	1,20,000
B (1 side open)	3 m x 2 m	1,10,000

For Exhibitors from India : Additional 10.30% service tax would be applicable on the above mentioned rates.

Participation package for each destination

With each stall comes a PARTICIPATION PACKAGE which consists of the following:

- » Standard Pre-Fabricated shell
- » Name board fascia
- » Fluorescent Light
- » Display panel walls on 2/3 sides
- » 1 Table and 2 chairs

And other services like

- » 2 lunch coupons per stall on the days of the fair.



A typical 3m x 2m stall

FLOOR PLAN - BANGKOK, THAILAND

06 & 07 Feb., 2010 (Sat & Sun)

Queen Sirikit National Convention Centre



Indian Schools Section

Indian Higher Education Section

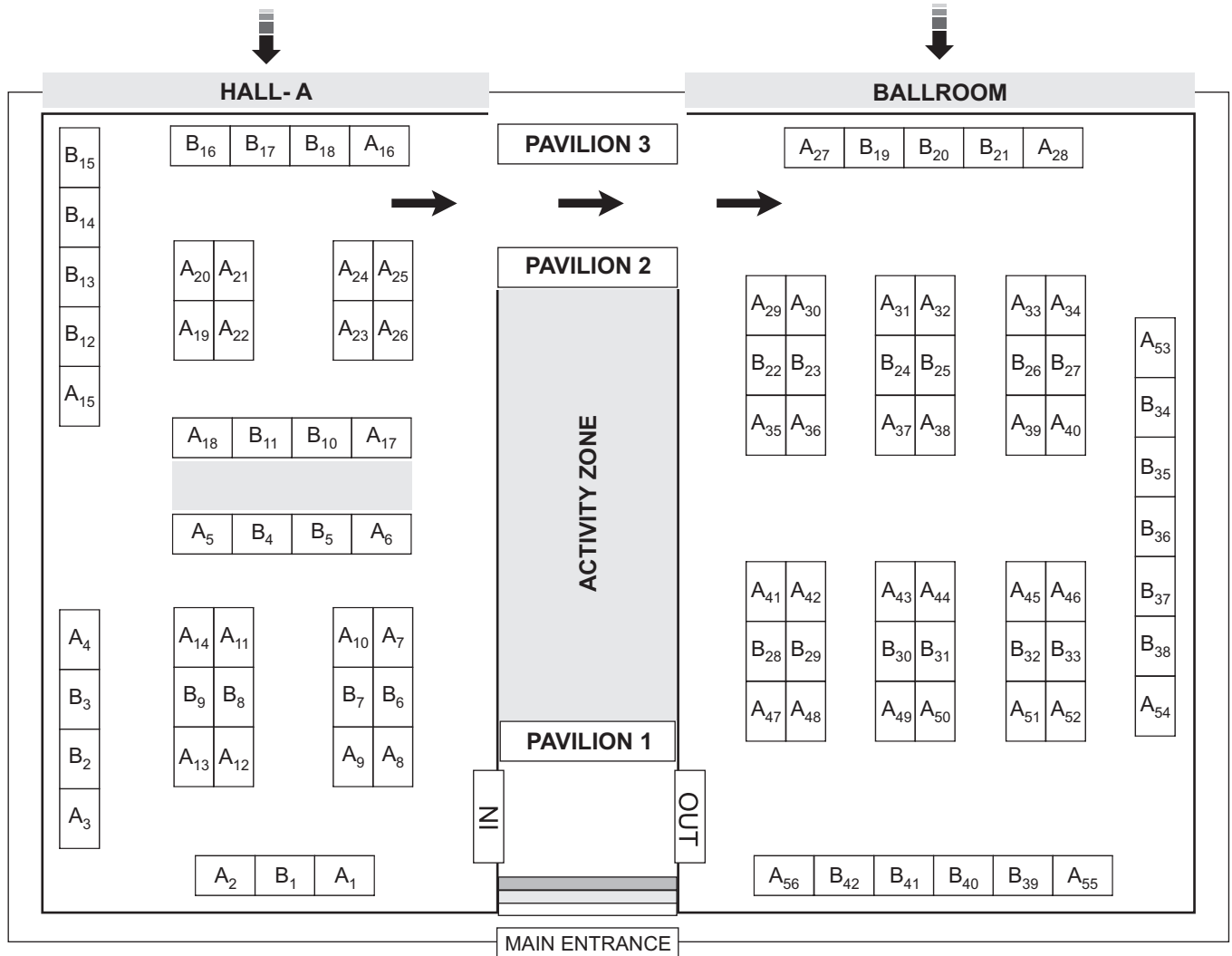

Not to Scale, Subject to Change

Stall Type	Stall Size	Rate (INR)
A (2 sides open)	3 m x 2 m	1,20,000
B (1 side open)	3 m x 2 m	1,10,000

For Exhibitors from India : Additional 10.30% service tax would be applicable on the above mentioned rates.

Participation package for each destination

With each stall comes a PARTICIPATION PACKAGE which consists of the following:

- » Standard Pre-Fabricated shell
- » Name board fascia
- » Fluorescent Light
- » Display panel walls on 2/3 sides
- » 1 Table and 2 chairs

And other services like

- » 2 lunch coupons per stall on the days of the fair.

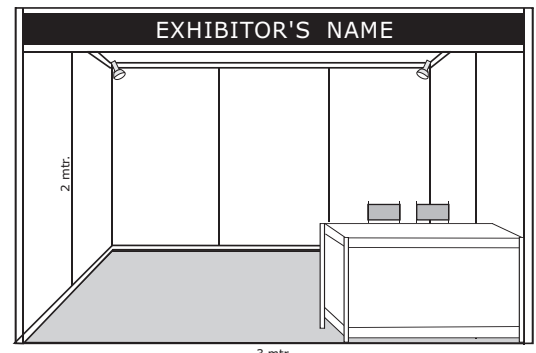

A typical 3m x 2m stall

FLOOR PLAN - THIMPHU, BHUTAN

03 & 04 April, 2010. (Sat - Sun)

Kelki Higher Secondary School

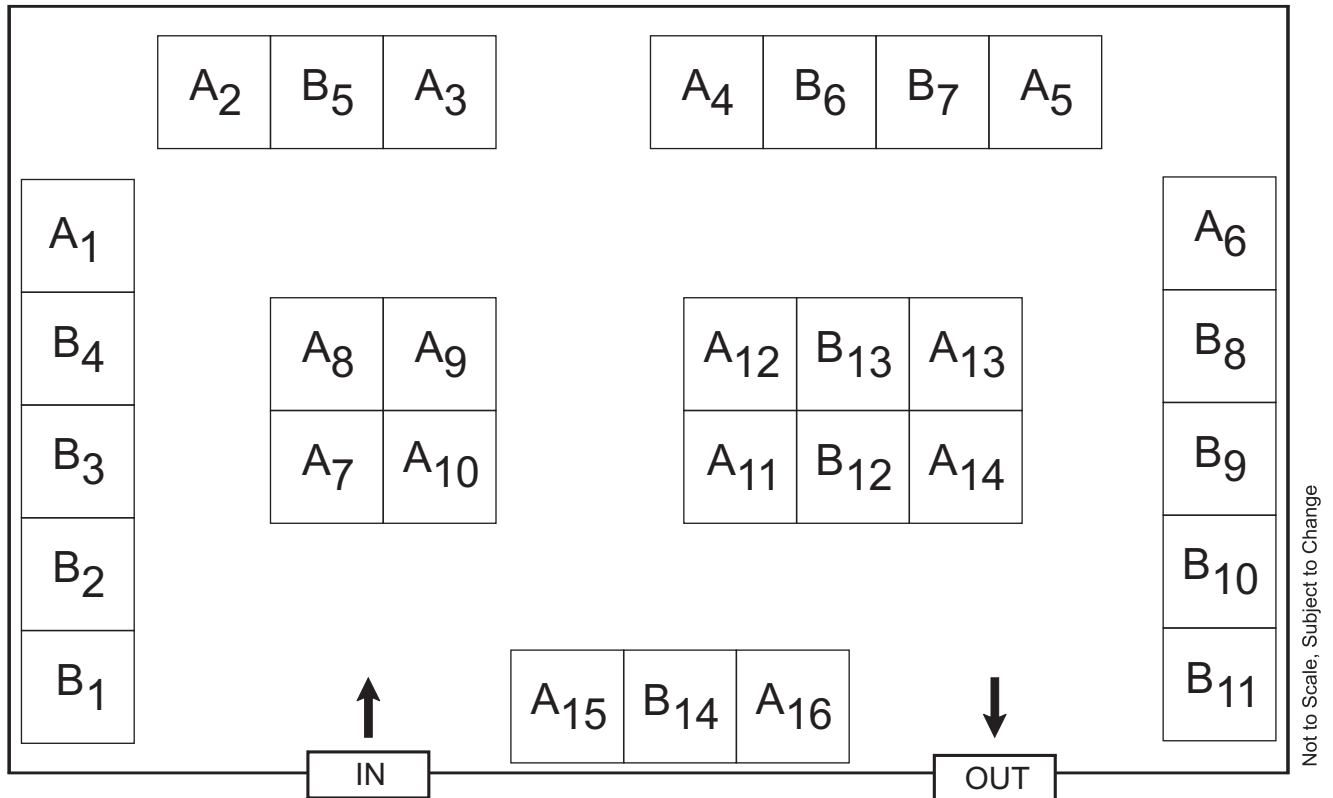

Type	Stall Size	Rate (INR)
A (2 sides open)	2 m x 2 m	70,000
B (1 side open)	2 m x 2 m	60,000

Additional 10.30% service tax would be applicable on the above mentioned rates.

Participation package for each destination

With each stall comes a PARTICIPATION PACKAGE which consists of the following:

- » Standard Pre-Fabricated shell
- » Display panel walls on 2/3 sides
- » Name board fascia
- » 1 Table and 2 chairs
- » 3 spotlights

And other services like

- » 2 lunch coupons per stall on the days of the fair.

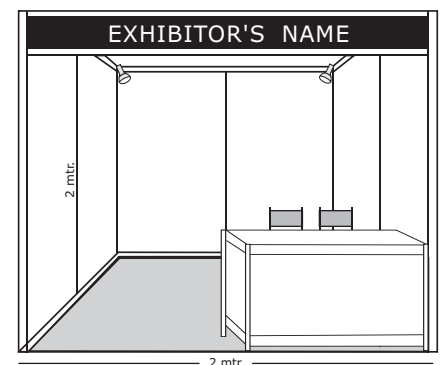

A typical 2m x 2m stall

FLOOR PLAN - COLOMBO, SRI LANKA

23, 24 & 25 April, 2010 (Fri - Sun)

Sri Lanka Exhibition & Convention Centre

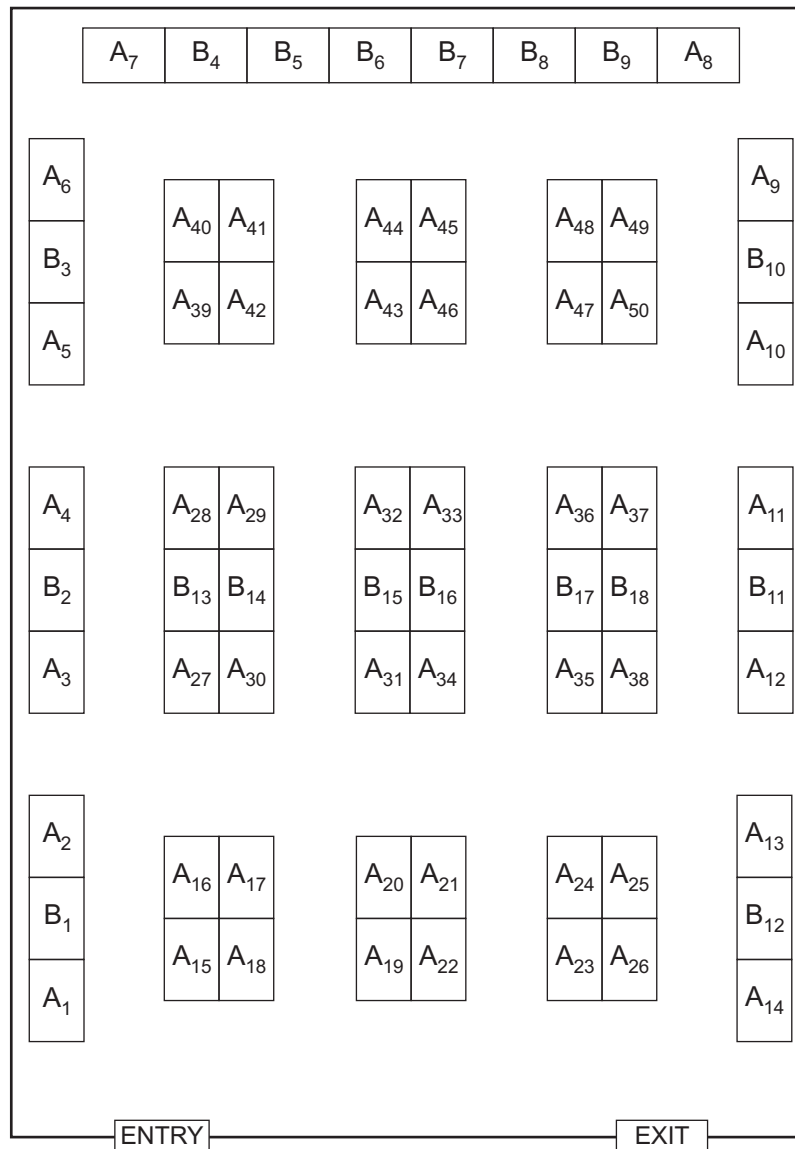

Stall Type	Stall Size	Rate (INR)
A (2 sides open)	3 m x 2 m	95,000
B (1 side open)	3 m x 2 m	85,000

For Exhibitors from India : Additional 10.30% service tax would be applicable on the above mentioned rates.

Participation package for each destination

With each stall comes a PARTICIPATION PACKAGE which consists of the following:

- » Standard Pre-Fabricated shell
- » Name board fascia
- » Fluorescent Light
- » Display panel walls on 2/3 sides
- » 1 Table and 2 chairs

And other services like

- » 2 lunch coupons per stall on the days of the fair.



A typical 3m x 2m stall

FLOOR PLAN - KATHMANDU, NEPAL

21 & 22 May, 2010 (Fri & Sat)

The Everest Hotel

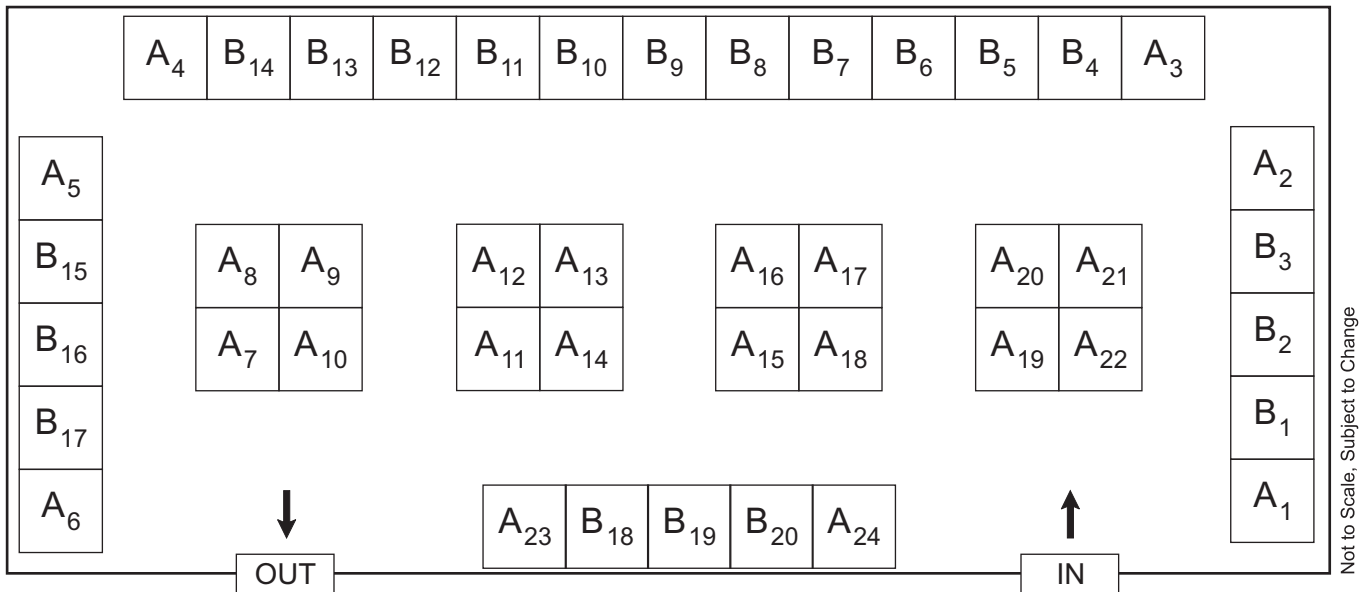

Type	Stall Size	Rate (INR)
A (2 sides open)	2 m x 2 m	70,000
B (1 side open)	2 m x 2 m	60,000

Additional 10.30% service tax would be applicable on the above mentioned rates.

Participation package for each destination

With each stall comes a PARTICIPATION PACKAGE which consists of the following:

- » Standard Pre-Fabricated shell
- » Display panel walls on 2/3 sides
- » Name board fascia
- » 1 Table and 2 chairs
- » 3 spotlights

And other services like

- » 2 lunch coupons per stall on the days of the fair.

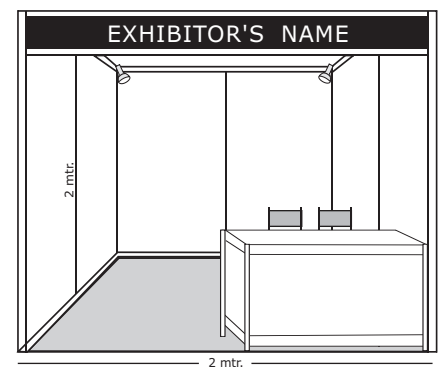

A typical 2m x 2m stall