

FLOOR PLAN - THIMPHU

28 - 29 March, 2009. (Sat - Sun)

Kelki Higher Secondary School

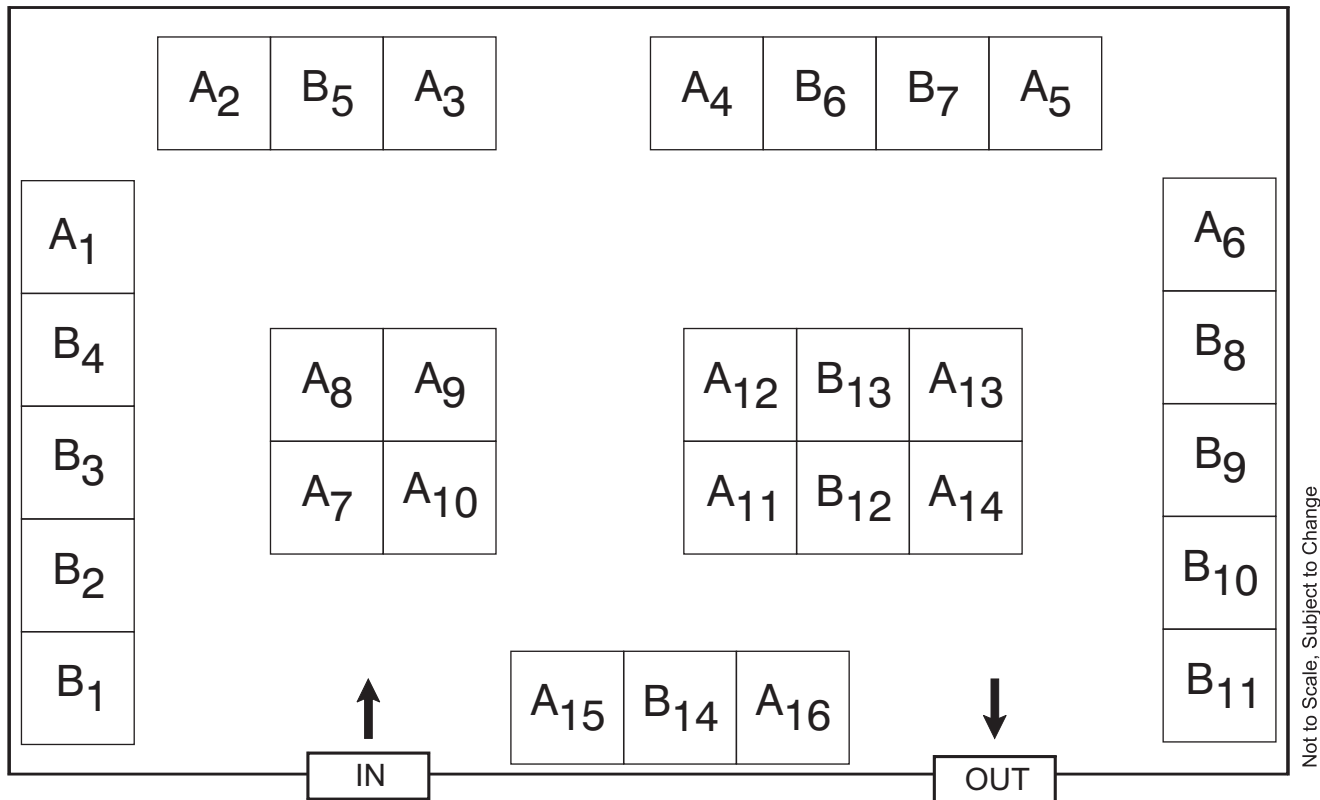

Type	Stall Size	Rate (INR)
A (2 sides open)	2 m x 2 m	60,000
B (1 side open)	2 m x 2 m	50,000

Additional 12.36% service tax would be applicable on the above mentioned rates.

Participation package for each destination

With each stall comes a PARTICIPATION PACKAGE which consists of the following:

- » Standard Pre-Fabricated shell
- » Name board fascia
- » 3 spotlights
- » Display panel walls on 2/3 sides
- » 1 Table and 2 chairs

And other services like

- » 2 lunch coupons per stall on the days of the fair.



A typical 2m x 2m stall

FLOOR PLAN - RANCHI

11 - 12 April, 2009. (Sat - Sun)

Hotel Capitol Hill

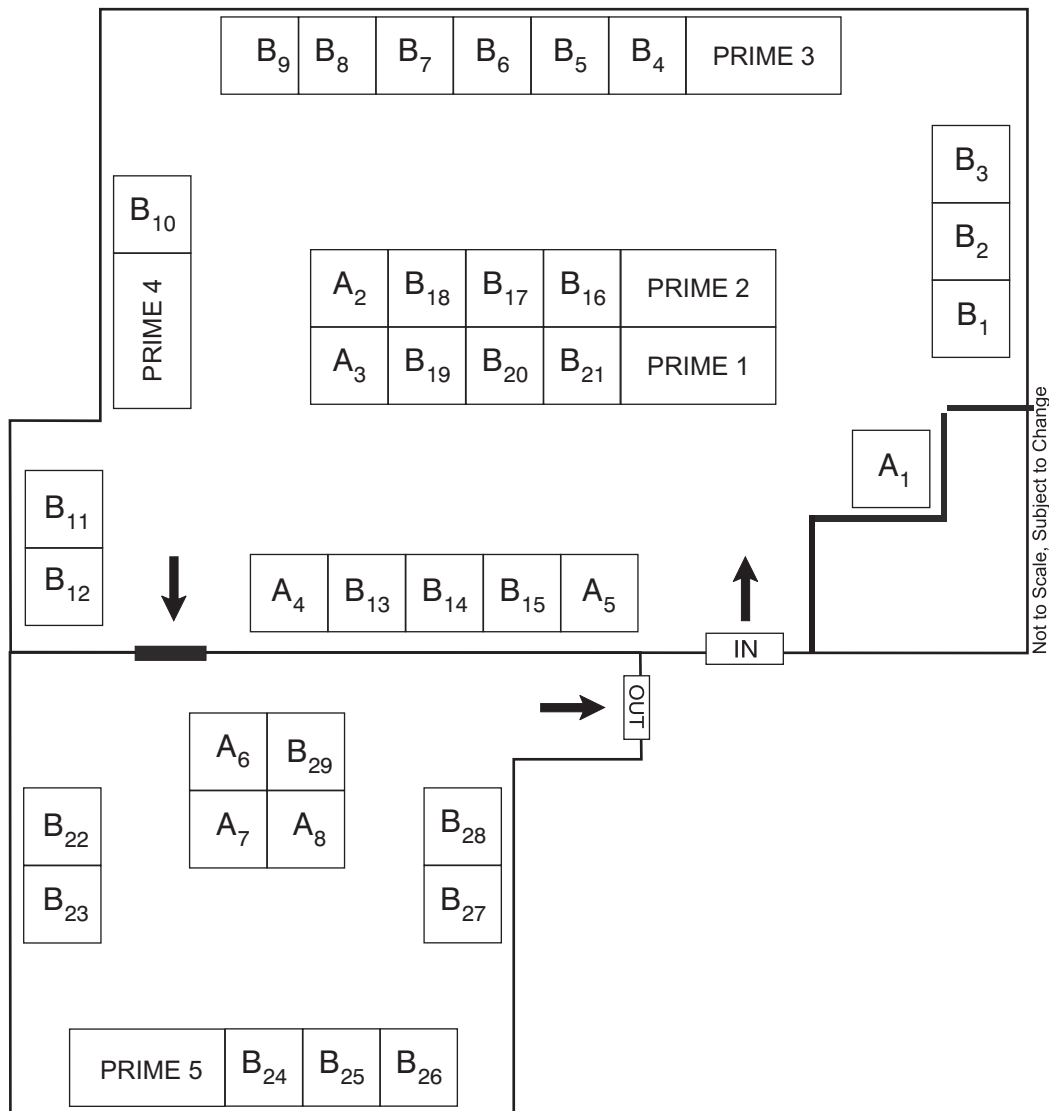

Type	Stall Size	Rate (INR)
Prime	4 m x 2 m	1,20,000
A (2 sides open)	2 m x 2 m	60,000
B (1 side open)	2 m x 2 m	50,000

Additional 12.36% service tax would be applicable on the above mentioned rates.

Participation package for each destination

With each stall comes a PARTICIPATION PACKAGE which consists of the following:

- » Standard Pre-Fabricated shell
- » Name board fascia
- » 3 spotlights
- » Display panel walls on 2/3 sides
- » 1 Table and 2 chairs

And other services like

- » 2 lunch coupons per stall on the days of the fair.



A typical 2m x 2m stall

FLOOR PLAN - PATNA

14 - 15 April, 2009. (Tue - Wed)

Hotel Chanakya

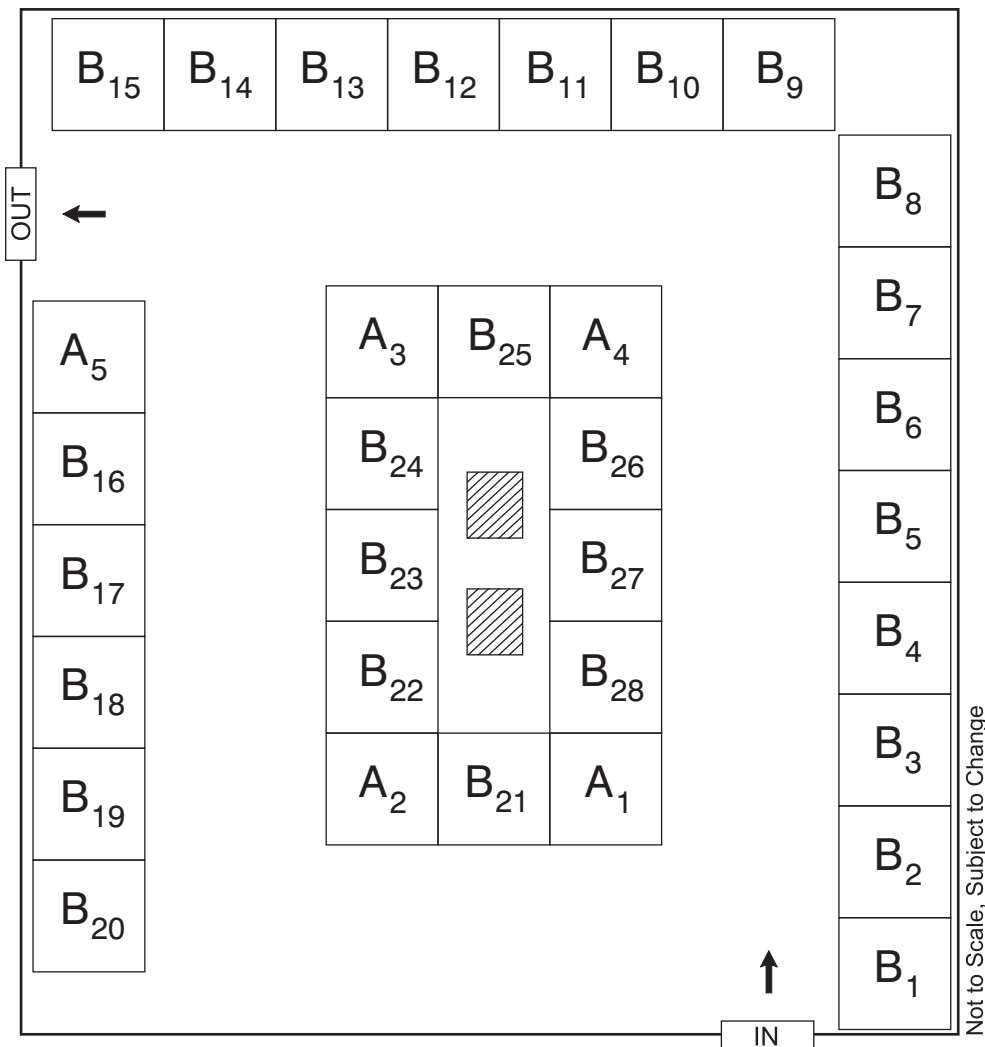

Type	Stall Size	Rate (INR)
A (2 sides open)	2 m x 2 m	60,000
B (1 side open)	2 m x 2 m	50,000

Additional 12.36% service tax would be applicable on the above mentioned rates.

Participation package for each destination

With each stall comes a PARTICIPATION PACKAGE which consists of the following:

- » Standard Pre-Fabricated shell
- » Display panel walls on 2/3 sides
- » Name board fascia
- » 1 Table and 2 chairs
- » 3 spotlights

And other services like

- » 2 lunch coupons per stall on the days of the fair.

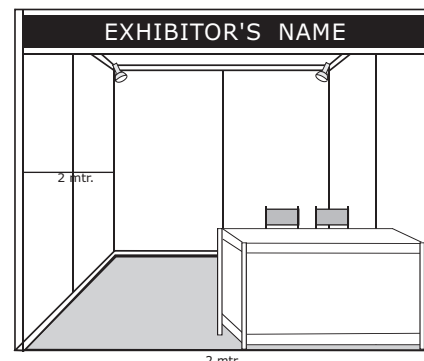

A typical 2m x 2m stall

FLOOR PLAN - KOLKATA

18 - 20 April, 2009. (Sat - Mon)

Ice Skating Rink

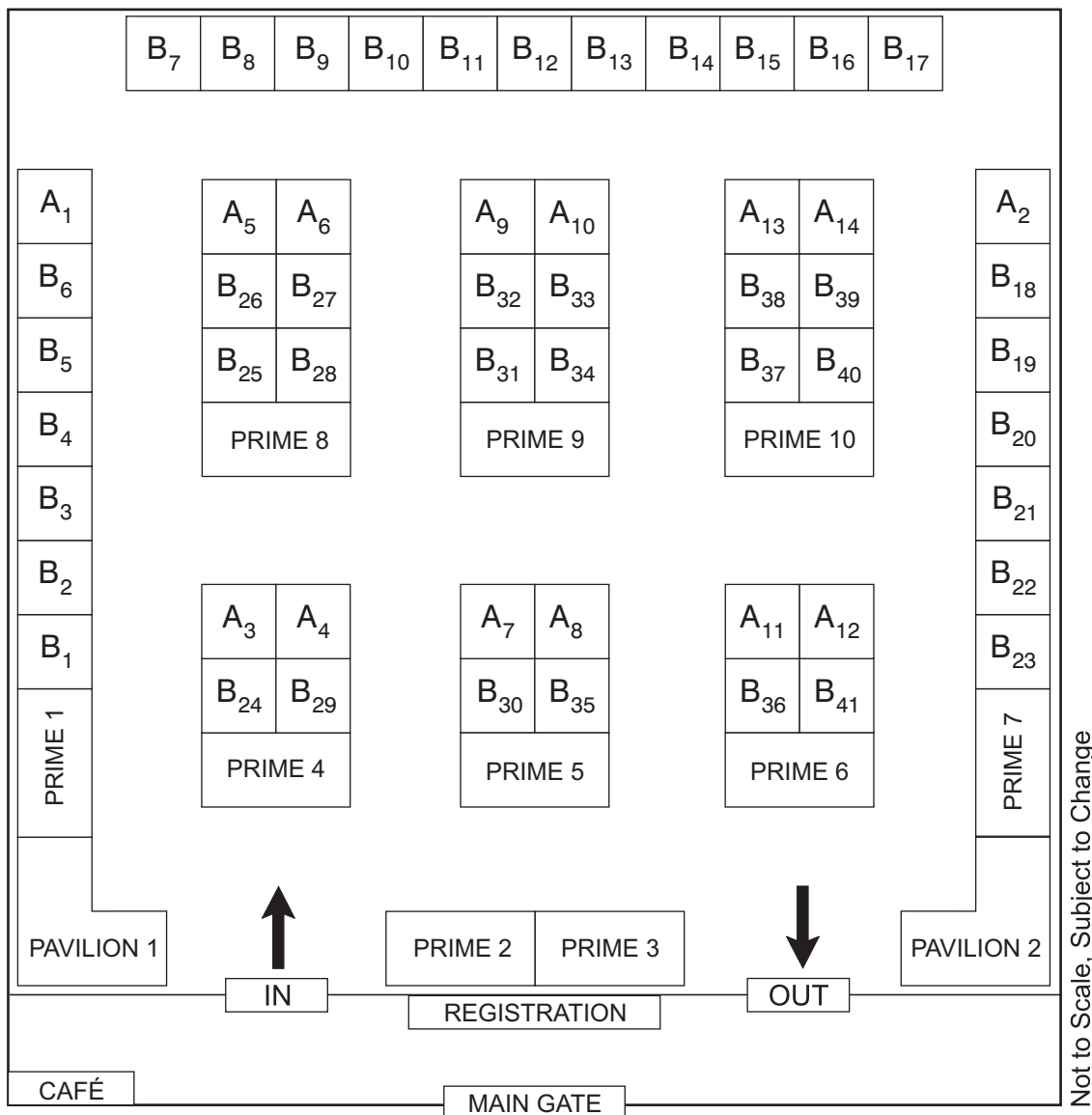

Type	Stall Size	Rate (INR)
Pavilion	12 sq. mtr	2,00,000
Prime	4 m x 2 m	1,50,000
A (2 sides open)	2 m x 2 m	70,000
B (1 side open)	2 m x 2 m	60,000

Additional 12.36% service tax would be applicable on the above mentioned rates.

Participation package for each destination

With each stall comes a PARTICIPATION PACKAGE which consists of the following:

- » Standard Pre-Fabricated shell
- » Display panel walls on 2/3 sides
- » Name board fascia
- » 1 Table and 2 chairs
- » 3 spotlights

And other services like

- » 2 lunch coupons per stall on the days of the fair.

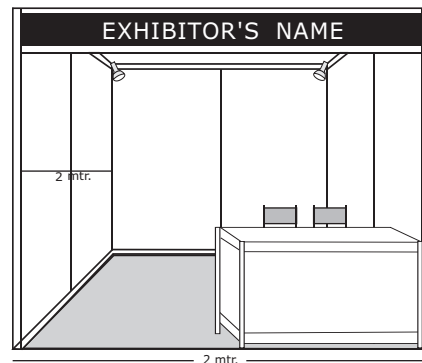

A typical 2m x 2m stall

FLOOR PLAN - LUCKNOW

25 - 26 April, 2009. (Sat - Sun)

Hotel Clarks Avadh

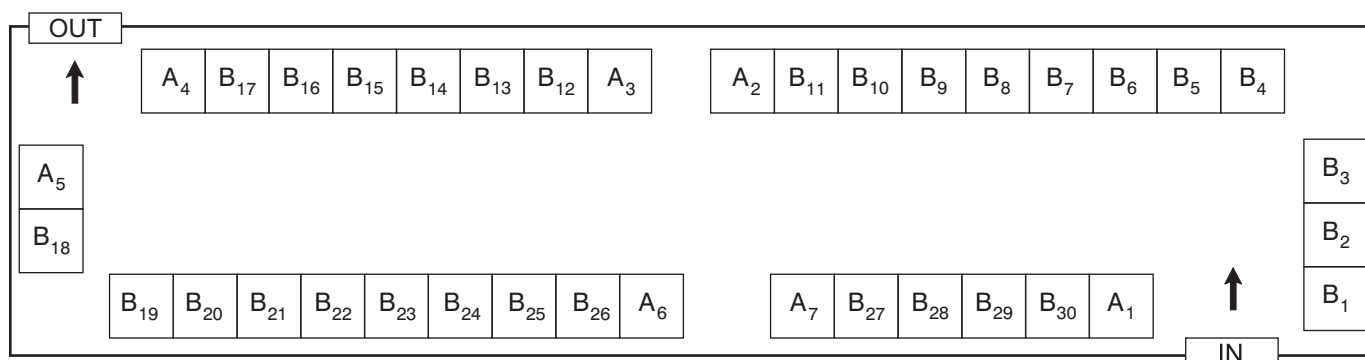

Type	Stall Size	Rate (INR)
A (2 sides open)	2 m x 2 m	70,000
B (1 side open)	2 m x 2 m	60,000

Additional 12.36% service tax would be applicable on the above mentioned rates.

Participation package for each destination

With each stall comes a PARTICIPATION PACKAGE which consists of the following:

- » Standard Pre-Fabricated shell
- » Display panel walls on 2/3 sides
- » Name board fascia
- » 1 Table and 2 chairs
- » 3 spotlights

And other services like

- » 2 lunch coupons per stall on the days of the fair.

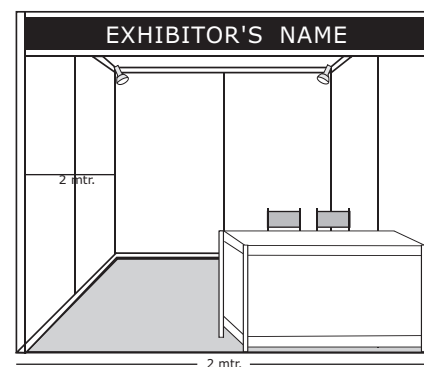

A typical 2m x 2m stall

FLOOR PLAN - KATHMANDU

01 - 02 May, 2009. (Fri - Sat)

The Everest Hotel

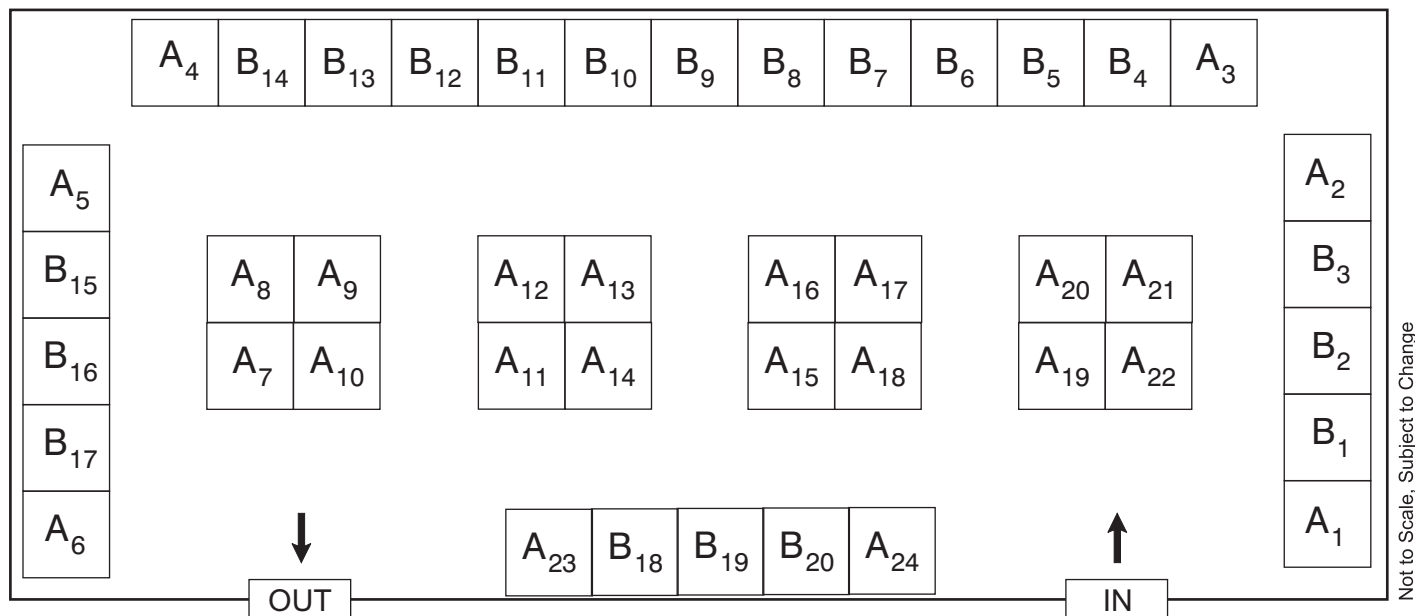

Not to Scale, Subject to Change

Type	Stall Size	Rate (INR)
A (2 sides open)	2 m x 2 m	60,000
B (1 side open)	2 m x 2 m	50,000

Additional 12.36% service tax would be applicable on the above mentioned rates.

Participation package for each destination

With each stall comes a PARTICIPATION PACKAGE which consists of the following:

- » Standard Pre-Fabricated shell
- » Display panel walls on 2/3 sides
- » Name board fascia
- » 1 Table and 2 chairs
- » 3 spotlights

And other services like

- » 2 lunch coupons per stall on the days of the fair.

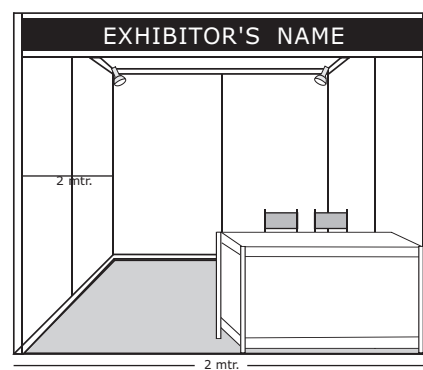

A typical 2m x 2m stall