

The Telegraph

CALCUTTA MONDAY 23 APRIL 2007 Rs 2.00

Defence steps out to swell ranks



Defence steps out to swell ranks. The armed forces have long been a popular choice for students...

Hindustan Times

CHENNAI, APRIL 23, 2007

Choices aplenty at career fair



Choices aplenty at career fair. The 15th Career Fair at the Ice Skating Rink...

TIMES OF INDIA

April 23, 2007

CAREER FAIR



The 15th Career Fair held at the Ice Skating Rink from April...

दैनिक जागरण

करियर मेले में पहले दिन उमड़े विद्यार्थी



करियर मेले में पहले दिन उमड़े विद्यार्थी. The fair was a success...

SUNDAY TIMES



Today's life, education and career undoubtedly occupy the most...

THE TELEGRAPH



To help one make the choice of a career not as mummy ordered...

Indian EXPRESS

Armed forces to organise career help desks at fair



Armed forces to organise career help desks at fair. The fair was a success...

A FAIR TO BE IN



Their 15th career fair at the Ice Skating Rink which started yesterday...

THE TELEGRAPH

Careers, options and questions



Careers, options and questions. The fair was a success...

Contents

- » Fact Sheet & Order Form Checklist
- » Sponsorship Details
- » Career Fair Series
 - Floor Plan - Kathmandu & Thimphu
 - Floor Plan - Ranchi & Patna
 - Floor Plan - Kolkata & Lucknow
 - Stall Rates & Participation Package
 - Form 1 - Stall Booking Contract Form
 - Form 2 - Career Guide Advertisement Form
- » Admission Fair Series
 - Floor Plan - Kolkata & Ranchi
 - Floor Plan - Patna & Raipur
 - Form 3 - Stall Booking Contract Form
 - Form 4 - Career Success Advertisement Form



Students studying abroad

'Students still prefer traditional courses'. Dhananjay Ranchi, April 27. IF THE response of the two-day 'Career Fair'...



Notice Board

Career Fair. THE 16th Career Fair will be held in Kolkata from 23 April to 27 April...

CITY	VENUE	DATES	TIMINGS	BOOKING DEADLINE
Thimphu BHUTAN	Kelki H. S. School Thimphu, Bhutan	28 & 29 March 2009 (Sat & Sun)	10 am to 6 pm	21st March 2009
Ranchi	Hotel Capitol Hill M.G. Marg, (Main Road) Ranchi - 834 001 Ph: 0651- 2331 330 - 5	11 & 12 April 2009 (Sat - Sun)	11 am to 8 pm	28th March 2009
Patna	Hotel Chanakya Beer Chand Patel Marg Patna - 800 001 Ph: 0612 2220590 - 96	14 & 15 April 2009 (Tue & Wed)	11 am to 8 pm	31st March 2009
Kolkata	Ice Skating Rink 78, Syed Amir Ali Avenue, Kolkata - 700 019	18, 19 & 20 April 2009 (Sat to Mon)	11 am to 8 pm	04th April 2009
Lucknow	Hotel Clarks Avadh 8, Mahatma Gandhi Marg, Lucknow - 226 001. Ph : (0522) 2620131-33	25 & 26 April 2009 (Sat & Sun)	11 am to 8 pm	11th April 2009
Kathmandu NEPAL	The Everest Hotel New Baneswor, Kathmandu Ph: 977-1-4780100 / 1010	01 & 02 May 2009 (Fri & Sat)	10 am to 6 pm	18th April 2009



CITY	VENUE	DATES	TIMINGS	BOOKING DEADLINE
Kolkata	Ice Skating Rink 78, Syed Amir Ali Avenue, Kolkata - 700 019	06, 07 & 08 June 2009 (Sat - Mon)	11 am to 8 pm	23rd May 2009
Ranchi	Hotel Capitol Hill M.G. Marg, (Main Road) Ranchi - 834 001 Ph: 0651- 2331 330 - 5	10 & 11 June 2009 (Wed & Thu)	11 am to 8 pm	30th May 2009
Patna	Hotel Chanakya Beer Chand Patel Marg Patna - 800 001 Ph: 0612 2220590 - 96	13 & 14 June 2009 (Sat - Sun)	11 am to 8 pm	30th May 2009
Raipur	Babylon International VIP Road, Rajiv Gandhi Marg, Raipur - 492006, Chattisgarh	20 - 21 June 2009 (Sat - Sun)	11 am to 8 pm	06th June 2009

Order Form Checklist

The various forms included in this manual have been designed to facilitate the preparation for the Exhibition. The forms in the following pages should be completed and a photocopy of the completed forms should be retained in your institution for reference purposes.

Form 1 : Stall Booking Contract Form - Career Fair Series

Form 2 : Career Guide Advertisement Form

Form 3 : Stall Booking Contract Form - Admissions Fair Series

Form 4 : Career Success Advertisement Form

Please Fax the forms to : **Vishal Shukla**

Fax No. : (033) 2286 5788

Exclusive Promotional Opportunities

18th Career Fair series & 6th Admissions Fair series offers organisations to strategically place themselves at the fore front of India's growing Education market. Selective promotional opportunities are on offer to highlight your presence.

Promotional opportunities to enhance your visibility.

SPONSORSHIP	Highlight your presence by associating as a Platinum / Gold / Silver Sponsor and create a lasting impression on the target visitors before and after the fair. Get immense mileage, visibility and branding in the following :	PLATINUM + 3 stalls Rs. 5,00,000 for Kolkata
	<ul style="list-style-type: none"> » All Press Advertisement in English & Vernacular daily » Publicity material like Posters / Kiosk / Banner / Hoarding » In venue Signage » Main Entrance Gate » E-mailer Invitation » Entry Tickets and Registration Forms » Official website » Stalls at prominent location 	GOLD + 2 stalls Rs. 4,00,000 for Kolkata
		SILVER + 1 stalls Rs. 3,50,000 for Kolkata
REGISTRATION	There will be a Registration & Ticket Counter at the Main Entrance to the hall. All visitors to the show would be requested to register themselves before entering. There would be a lucky draw for the visitors on Registration.	
	We will provide you with : <ul style="list-style-type: none"> » Your Name / Logo on the Registration Backdrop » Your Name / Logo in the Registration forms and Tickets Please note the Registration & Tickets counter would be handled by our people and a photocopy of the Registration slips will be handed over to you after the fair.	Rs.70,000 for Kolkata & Rs.50,000 each for all other locations
MAIN GATE	There will be an attractive Gate to the fair at the main entrance facing the main road.	
	<ul style="list-style-type: none"> » Your Name / Logo would be on both the panel walls of the Gate. 	Rs.50,000 for Kolkata & Rs.35,000 each for all other locations
FAIR BAG	An attractive Bag would be given to the visitors on Registration. 10,000 pcs. would be distributed on a first come first basis.	
	<ul style="list-style-type: none"> » Your Name / Logo on one side of the Bag. » Brochures / Pamphlets supplied by you could also be inserted in the Bags which would enable to have a lasting impression. 	Rs.80,000 for 10,000 bags for Kolkata & Rs.50,000 for 6,000 bags each for all other locations
INSERTS	Your Brochures / Pamphlets would be inserted in the bags which would be distributed from the Registration Counter.	
	Maximum number would be 10,000 pcs. to be supplied by you. Other Promotional Merchandise like T-Shirts, Pens, Caps etc could also be inserted.	Rs.10,000 per city

Packages can also be specially designed and tailored according to the organisations business development plan. Innovative ideas and suggestions are welcome.

Thimphu - Bhutan

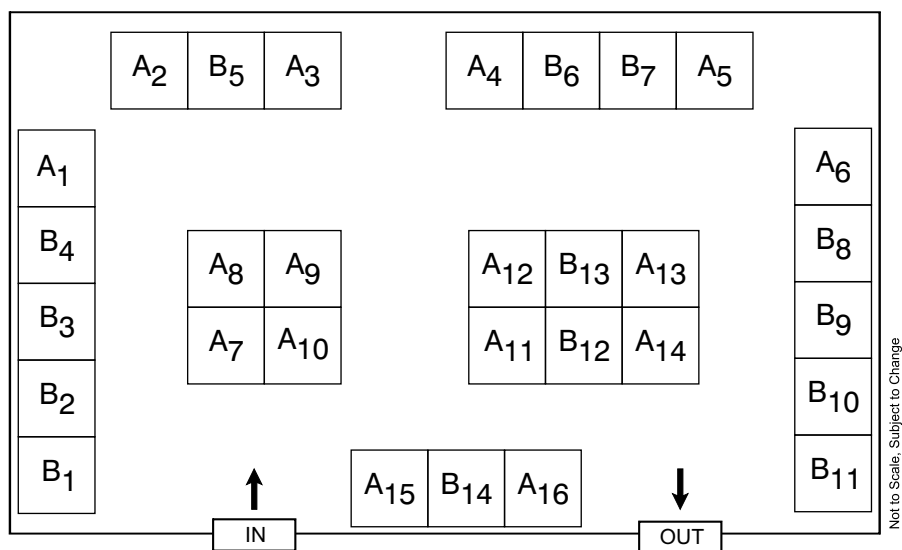

THIMPHU
28 & 29 March 2009 (Sat & Sun)
Kelki H. S. School

Stall Type	Stall Size	Rate (INR)
A (2 sides open)	2 m x 2 m	60,000
B (1 side open)	2 m x 2 m	50,000

Additional 12.36% service tax would be applicable on the above mentioned rates.

Kathmandu - Nepal

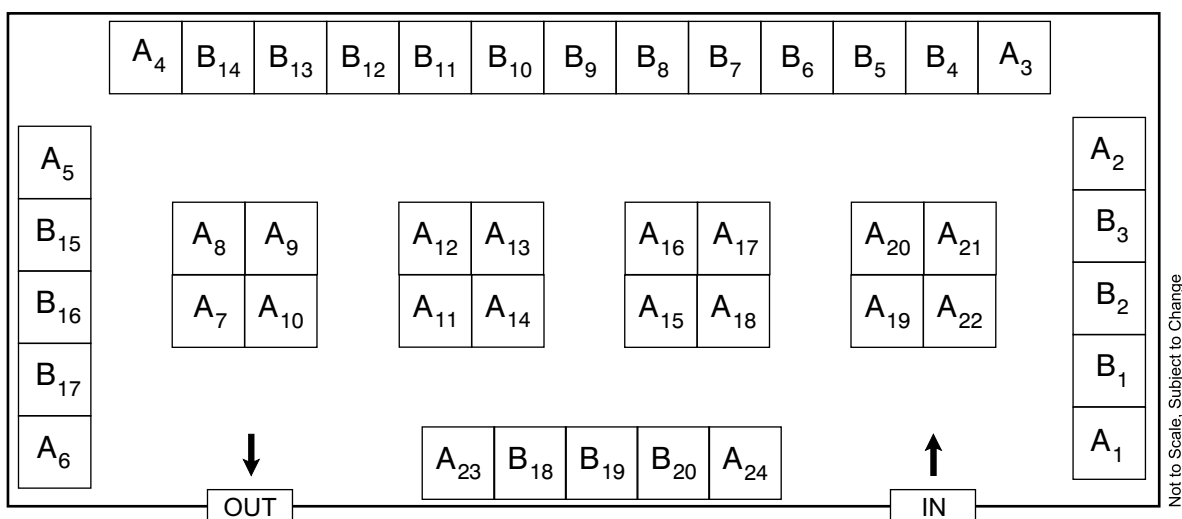

KATHMANDU
01 & 02 May 2009 (Fri & Sat)
The Everest Hotel

Stall Type	Stall Size	Rate (INR)
A (2 sides open)	2 m x 2 m	60,000
B (1 side open)	2 m x 2 m	50,000

Additional 12.36% service tax would be applicable on the above mentioned rates.

With each stall comes a PARTICIPATION PACKAGE which consists of the following:

- Standard Pre-Fabricated shell
- Display panel walls on 2/3 sides
- Name board fascia
- 1 Table and 2 chairs
- 3 spotlights
- 2 lunch coupons per stall

Floor Plans

Ranchi

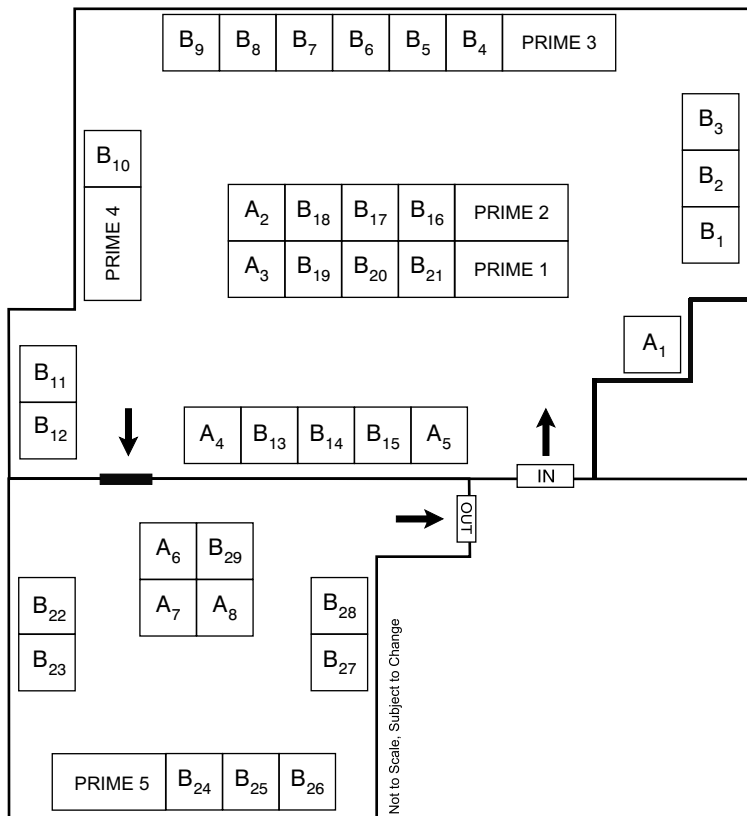

RANCHI	
11 & 12 April 2009 (Sat - Sun)	
Hotel Capitol Hill	

Stall Type	Stall Size	Rate (INR)
PRIME	4 m X 2 m	1,20,000
A (2 sides open)	2 m x 2 m	60,000
B (1 side open)	2 m x 2 m	50,000

Additional 12.36% service tax would be applicable on the above mentioned rates.

Patna

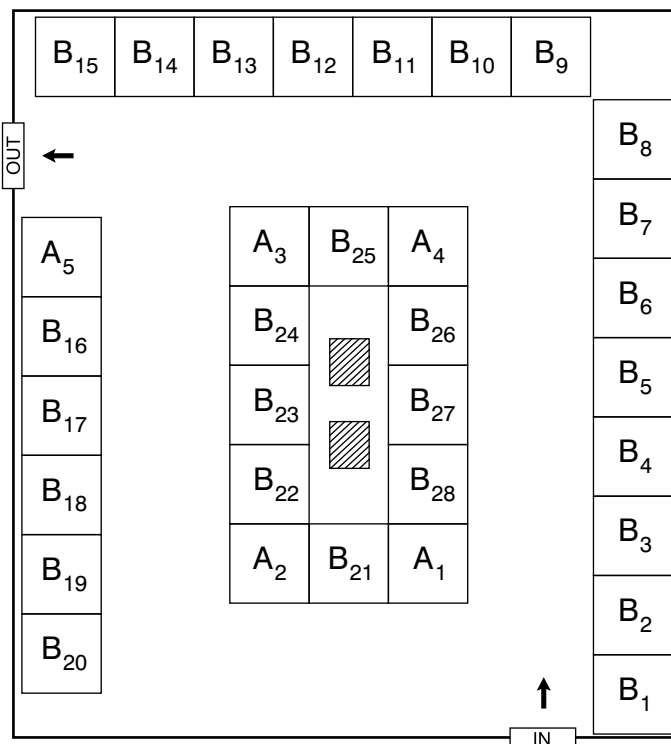

PATNA	
14 & 15 April 2009 (Tue - Wed)	
Hotel Chanakya	

Stall Type	Stall Size	Rate (INR)
A (2 sides open)	2 m x 2 m	60,000
B (1 side open)	2 m x 2 m	50,000

Additional 12.36% service tax would be applicable on the above mentioned rates.

With each stall comes a PARTICIPATION PACKAGE which consists of the following:

- Standard Pre-Fabricated shell
- Display panel walls on 2/3 sides
- Name board fascia
- 1 Table and 2 chairs
- 3 spotlights
- 2 lunch coupons per stall

Kolkata

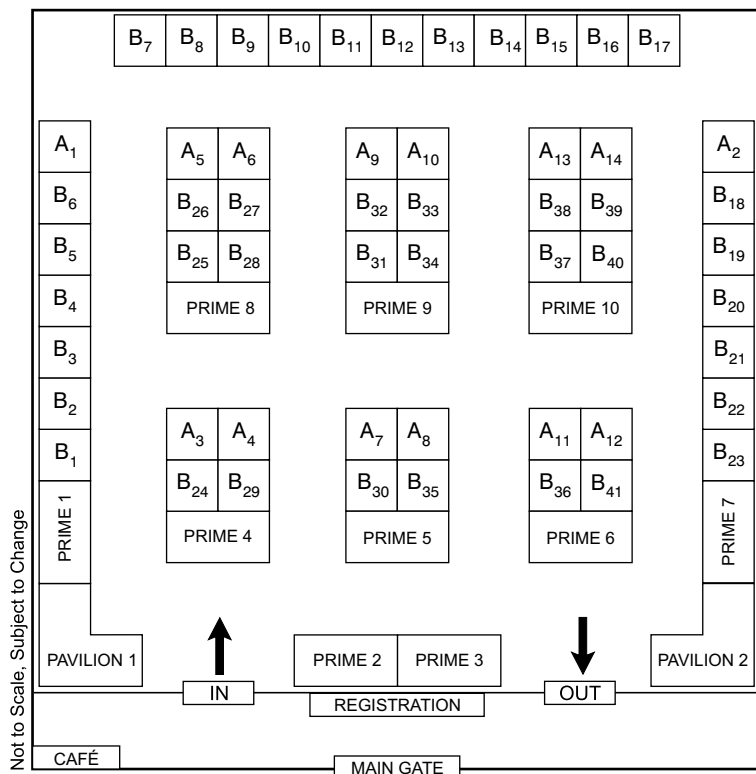

KOLKATA	
18, 19 & 20 April 2009 (Sat, Sun & Mon)	
Ice Skating Rink	

Stall Type	Stall Size	Rate (INR)
Pavilion	12 sq.mtr	2,00,000
Prime	4 m x 2 m	1,50,000
A (2 sides open)	2 m x 2 m	70,000
B (1 side open)	2 m x 2 m	60,000

Additional 12.36% service tax would be applicable on the above mentioned rates.

Lucknow

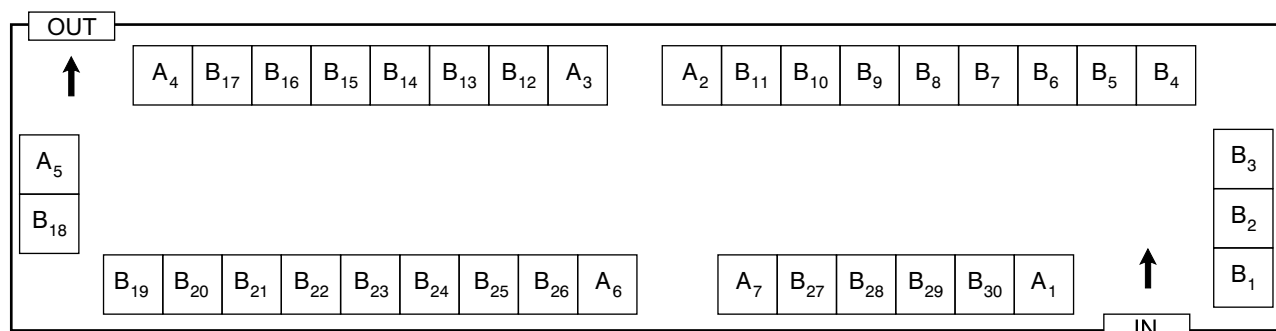

LUCKNOW	
25 & 26 April 2009 (Sat - Sun)	
Hotel Clarks Avadh	

Stall Type	Stall Size	Rate (INR)
A (2 sides open)	2 m x 2 m	70,000
B (1 side open)	2 m x 2 m	60,000

Additional 12.36% service tax would be applicable on the above mentioned rates.

With each stall comes a PARTICIPATION PACKAGE which consists of the following:

- Standard Pre-Fabricated shell
- Display panel walls on 2/3 sides
- Name board fascia
- 1 Table and 2 chairs
- 3 spotlights
- 2 lunch coupons per stall

Stall Rates & Participation Package

18th Career Fair series

City	Type	Stall Size	Rate (INR)
Thimphu-Bhutan	A (2 sides open)	2 m x 2 m	60,000
	B (1 side open)	2 m x 2 m	50,000
Ranchi	Prime Stall	4 m x 2 m	1,20,000
	A (2 sides open)	2 m x 2 m	60,000
	B (1 side open)	2 m x 2 m	50,000
Patna	A (2 sides open)	2 m x 2 m	60,000
	B (1 side open)	2 m x 2 m	50,000
Kolkata	Pavilion	12 sq. mtr	2,00,000
	Prime Stall	4 m x 2 m	1,50,000
	A (2 sides open)	2 m x 2 m	70,000
	B (1 side open)	2 m x 2 m	60,000
Lucknow	A (2 sides open)	2 m x 2 m	70,000
	B (1 side open)	2 m x 2 m	60,000
Kathmandu-Nepal	A (2 sides open)	2 m x 2 m	60,000
	B (1 side open)	2 m x 2 m	50,000

*Additional 12.36% service tax would be applicable on the above mentioned rates.

6th Admissions Fair series

City	Type	Stall Size	Rate (INR)
Kolkata	Pavilion	12 sq. mtr	2,00,000
	Prime Stall	4 m x 2 m	1,50,000
	A (2 sides open)	2 m x 2 m	70,000
	B (1 side open)	2 m x 2 m	60,000
Ranchi	Prime Stall	4 m x 2 m	1,20,000
	A (2 sides open)	2 m x 2 m	60,000
	B (1 side open)	2 m x 2 m	50,000
Patna	A (2 sides open)	2 m x 2 m	60,000
	B (1 side open)	2 m x 2 m	50,000
Raipur	A (2 sides open)	2 m x 2 m	60,000
	B (1 side open)	2 m x 2 m	50,000

*Additional 12.36% service tax would be applicable on the above mentioned rates.

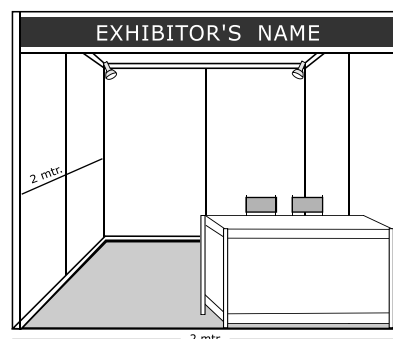

A typical 2m x 2m stall

Participation package for each destination

With each stall comes a PARTICIPATION PACKAGE which consists of the following:

- » Standard Pre-Fabricated shell
- » Display panel walls on 2/3 sides
- » Name board fascia
- » 1 Table and 2 chairs
- » 3 spotlights

And other services like

- » 2 lunch coupons per stall on the days of the fair.

Stall Booking & Terms of Payments

Booking of stall is strictly on first come first serve basis, accompanied by a 50% amount as advance by way of Cheque / DD to be made in favour of "AFAIRS Exhibitions & Media Pvt. Ltd." payable at Kolkata. **The balance payment is to be made one month prior to the exhibition date.** No booking of stall shall be confirmed unless the entire amount has been cleared.

Payment by Indian Exhibitor	Payment by Foreign Exhibitor
<p>The payment is to be transferred to ICICI Bank Ltd. Details are :</p> <p>Bank : ICICI Bank Limited, Chowringhee Branch, Kolkata</p> <p>Account Name : AFAIRS Exhibitions & Media Pvt. Ltd.</p> <p>Account Number : 018705008103</p>	<p>The payment is to be transferred to ABN AMRO Bank. Details are :</p> <p>Bank : ABN Amro Bank, Camac Street Branch, Kolkata, India</p> <p>Account Name : AFAIRS Exhibitions & Media Pvt. Ltd.</p> <p>Account Number : 1496537</p> <p>Swift Code : ABNAINBBAL</p>

Cancellations

In case the Exhibitor cancels the stall, the following condition will apply. **8 weeks** prior to the exhibition - 75% of the refund of stall charges. **4 – 8 weeks** prior to the exhibition – 50% of the refund of stall charges. **Less than 4 weeks** prior to the exhibition – no refund.

Stall Booking Contract Form for Indian & Foreign Destination

Institution Details

» Contact Person

» Position or job title

» Institution name

» Address

City	Pin code
------	----------

» Phone

» Cell

» Fax

» Email

» Website

» Affiliation

» Name board Fascia to be written on Stall

» Signature & Seal

Date			
------	--	--	--

To
AFAIRS Exhibitions & Media Pvt. Ltd.
 33, Dr. Sundari Mohan Avenue
 Kolkata - 700 014

Dear Sir,

We have read the "Terms and Conditions" set out overleaf and accept them and would like to book space at the following cities

» **Bhutan** (28 - 29 March. '09, Kelki H. S. School, Thimphu)

Stall No.	Size	Amount (INR)

» **Ranchi** (11 - 12 April '09, Hotel Capitol Hill)

Stall No.	Size	Amount (INR)

» **Patna** (14 - 15 April. '09, Hotel Chanakya)

Stall No.	Size	Amount (INR)

» **Kolkata** (18 - 20 April. '09, Ice Skating Rink)

Stall No.	Size	Amount (INR)

» **Lucknow** (25 - 26 April. '09, Hotel Clarks Avadh)

Stall No.	Size	Amount (INR)

» **Kathmandu** (01 - 02 May. '09, The Everest Hotel)

Stall No.	Size	Amount (INR)

Add 12.36% Service Tax

Total Amount

We enclose our DD / Cheque No.

Dated on Bank

for Rs. in favour of **AFAIRS Exhibitions &**

Media Pvt. Ltd., payable at Kolkata towards advance and undertake to pay the **balance by one month prior to the exhibition date.**

OTHER PAYMENT OPTIONS (Please Tick)

We have transferred the Amount to your Bank account
 Account Name : AFAIRS Exhibitions & Media Pvt. Ltd.
 Account No. : 018705008103
 Bank : ICICI Bank Ltd, Chowringhee Road Branch,
 Kolkata
(Photocopy of Cheque / DD is attached alongwith the deposit slip)

Wire transfer the Amount to your Bank account
 Account Name : AFAIRS Exhibitions & Media Pvt. Ltd.
 Account No. : 1496537
 Bank : ABN Amro Bank, Camac Street Branch,
 Kolkata, India
 Swiftcode : ABNAINBBCL

Please Fax this form to 033 - 2286 5788

Please draw the Cheque/DD in favour of
"AFAIRS EXHIBITIONS & MEDIA PVT. LTD."

Terms And Conditions

This booking order form will be governed by the following terms and conditions. The terms and conditions stipulated here are not negotiable unless and until specifically agreed to in writing by AFAIRS Exhibitions & Media Pvt. Ltd. Exhibitors are requested to study the terms and conditions carefully before finalizing their participation.

1. For purposes of this order the word "Organiser" will refer to AFAIRS Exhibitions & Media Pvt. Ltd. having their office at 33, Dr. Sundari Mohan Avenue, Kolkata - 700 014 and the word Exhibitor will refer to the person and/or company who has completed this stall booking contract form.
2. The booking of stall has to be made along with an advance payment of 50% by way of crossed cheque or D.D. drawn in favour of **AFAIRS EXHIBITIONS & MEDIA PVT. LTD.** Along with the Stall Booking Contract Form duly filled and signed by a competent authority. **The balance payment is to be made one month prior to the exhibition date.** Any extra charges payable towards additional services are to be paid in cash at the venue.
3. All Exhibitors are required to comply with all the provisions of Service Tax, Sales Tax Act Regulations or any Taxes and Levies as applicable by Govt. of India enforceable at the time of the Fair.
4. Exhibitors are requested to note that all floor plans shown in the brochure are tentative and the organiser reserve the right to amend the floor plan. Further, the organiser are not liable for any change in the venue or date arising from circumstances beyond their control.
5. In case of the event being cancelled or suspended in whole or in part for causes not in the Organiser control, the organiser do not accept any consequential liability in any such eventuality, Disputes are subject to Calcutta Court Jurisdiction.
6. The Exhibitors are requested to bring their own stabilizer/inverter/UPS/spike busters etc. for a stabilized supply of power to their equipments, since the organiser cannot ensure stabilised power supply.
7. The rates do not include charges for extra lighting or decoration, demonstrators or sales personnel etc, which may be arranged on specific requests.
8. Although arrangements for round-clock security will be made by the organiser, the Exhibitors will be solely responsible for the safety of their goods.
9. Exhibitors will be fully responsible for any damage done to the premises, furniture and fixtures provided to them, and will have to make payments for any such loss / damage and the decision of the organiser in this respect will be final.
10. Any damage / loss caused to goods suffered by the exhibitor owing to pilferage, fire, rain, floods, riots, strike or accident or malicious intent during transport and carriage or at the venue owing to the same or any other reasons whatsoever shall not be made good by the organiser to the concerned exhibitor.
11. Allotment of stall location will be generally on a first-come-first served basis. The organiser reserve the right to allot stall locations as per categorisation and their decision in this regard shall be final.
12. The Exhibitors cannot sublet the stalls to third parties, transfer the stalls, utilize the stalls, other than which the said stall has been contracted for.
13. Fixing of nails, screws, bolts, etc. and painting directly on display panels provided is not permitted except on taking permission from the organiser present.
14. Goods Materials/Objects which are hazardous, inflammable, banned or forbidden, or deemed inappropriate by the organiser will not be allowed in the venue.
15. Disassembly and removal of all materials will have to be done on the same day after the end of the show, material can be taken out from the Exhibition site against authorised GATE PASS only.
16. The organiser shall have a lien over the Exhibitors goods in case of his/her default in any manner.
17. Under no circumstances will money be refunded by the organiser in case of cancellations on part of the Exhibitor who has booked stalls.
18. The organiser reserve the right to cancel the stall booking any time before or during the event, by refunding the money received, at their sole discretion and without assigning any reason. In case the stall is cancelled due to misbehaviour and unethical practice by the Exhibitor, money shall not be refunded to the Exhibitor.
19. The organiser may cancel, suspend or alter dates of the exhibition owing to circumstances beyond its control. In case of change in dates and duration of the Exhibition the contractual obligation between the Exhibitor and Organiser remains unaffected. However, the organiser stand indemnified against excessive / low turnout of visitors / premature closure or suspension of the exhibition due to unavoidable circumstances. The same shall apply if the exhibition is cancelled due to riots, strike, rain, flood, earthquake or any manmade / natural disaster, including untimely demise of either exhibitor or organiser.
No Refunds will be made by the organiser in the event any situation as described above arises.
20. In case the Exhibitors does not take possession of the stalls by 2 p.m. on the opening day the organiser reserve the right to allot the stalls to others without refunding the advances made.
21. Stall booking contract will be deemed completed only after full payment is made and the organiser have accepted the booking.
22. All exhibitor will strictly abide by the rules, regulations, terms & conditions as prescribed herewith.

Career Guide Advertisement Form

Why you must advertise in the Career Guide ?

- » Multiple advantage - **one Advertisement** insures a guaranteed **reach** to your target audience at the **important cities of India**.
- » **Minimum 40,000 copies** to be distributed **FREE** along with entry tickets.
- » Highlight your presence by advertising in the Career Guide, which will have valuable information about various Career options, specialized articles from Education experts, Advertisements, etc.
- » The Career Guide will be a complete ready reckoner for students around the year and will have **immense retentive value**.
- » **Highly cost effective medium** to reach your target audience.
- » **Mechanical Specification**
 - # Print Area : **21.5 cm x 15.3 cm**
 - # B/W Ads : Laser printouts 600dpi min. (no halftone pictures)
 - # Colour Ads : Design to be given on CD or Floppy
- » Material will be accepted in CD as CorelDraw-12, Photoshop, Freehand -10, Picture format (JPG, TIF, EPS, PDF with min. of 300dpi resolution in Greyscale or CMYK).
- » **Material Deadline : 14th March 2009**

**Reach out
cost effectively
@ 50 paise per student**



You may also e-mail the artwork at : info@afairs.com

For Booking Advertisements please fill in the Advertisement Booking form below with details and send it immediately along with the Cheque / D D in favour of "**AFAIRS Exhibitions & Media Pvt. Ltd.**" payable at Kolkata.

-----Tear here-----

To
AFAIRS Exhibitions & Media Pvt. Ltd.
33, Dr. Sundari Mohan Avenue, 2nd Floor, Kolkata - 700 014.

Please book an advertisement space in the Career Guide. The details are as follows :

OPTION	RATE	OPTION	RATE
<input type="checkbox"/> Back Cover (Colour)	Rs. 50,000/-	<input type="checkbox"/> Full Page (Colour)	Rs. 30,000/-
<input type="checkbox"/> Front Inside (Colour)	Rs. 45,000/-	<input type="checkbox"/> Full Page (B/W)	Rs. 20,000/-
<input type="checkbox"/> Back Inside Cover (Colour)	Rs. 40,000/-	* 12.36 % Service Tax will be applicable on the above rates	

Material is being sent as CD Floppy E-mail

Enclosed is our Cheque / Draft no. date

on Bank for Rs

rupees in words

Name of the organisation

Address

Phone Fax

Contact Person

Date 09

Signature & Seal

Kolkata

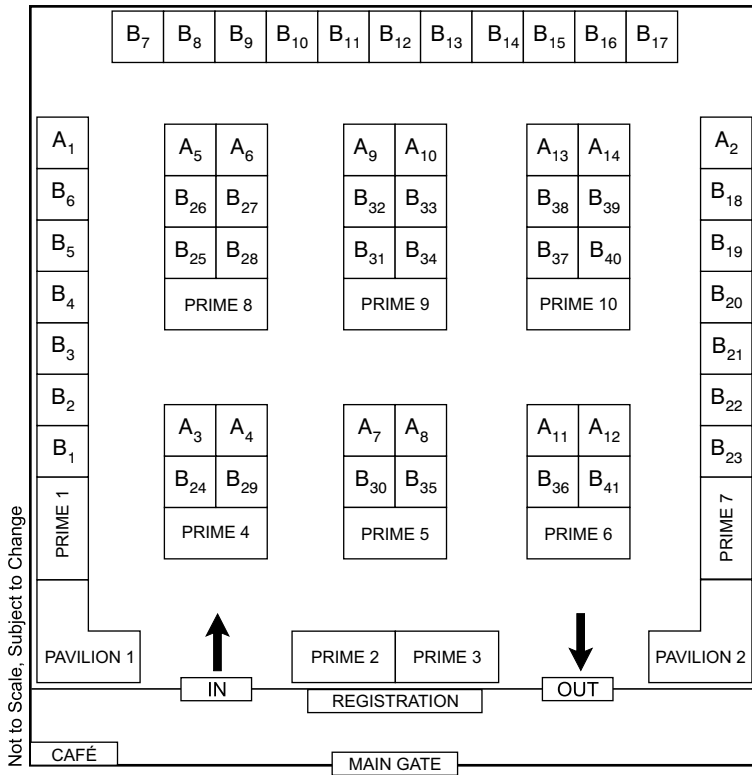

KOLKATA
06, 07 & 08 June 2009
(Sat, Sun & Mon)
Ice Skating Rink

Stall Type	Stall Size	Rate (INR)
Pavilion	12 sq.mtr	2,00,000
Prime	4 m x 2 m	1,50,000
A (2 sides open)	2 m x 2 m	70,000
B (1 side open)	2 m x 2 m	60,000

Additional 12.36% service tax would be applicable on the above mentioned rates.

Not to Scale. Subject to Change

Ranchi

RANCHI
10 & 11 June 2009
(Wed - Thu)
Hotel Capitol Hill

Stall Type	Stall Size	Rate (INR)
PRIME	4 m X 2 m	1,20,000
A (2 sides open)	2 m x 2 m	60,000
B (1 side open)	2 m x 2 m	50,000

Additional 12.36% service tax would be applicable on the above mentioned rates.

With each stall comes a PARTICIPATION PACKAGE which consists of the following:

- Standard Pre-Fabricated shell
- Display panel walls on 2/3 sides
- Name board fascia
- 1 Table and 2 chairs
- 3 spotlights
- 2 lunch coupons per stall

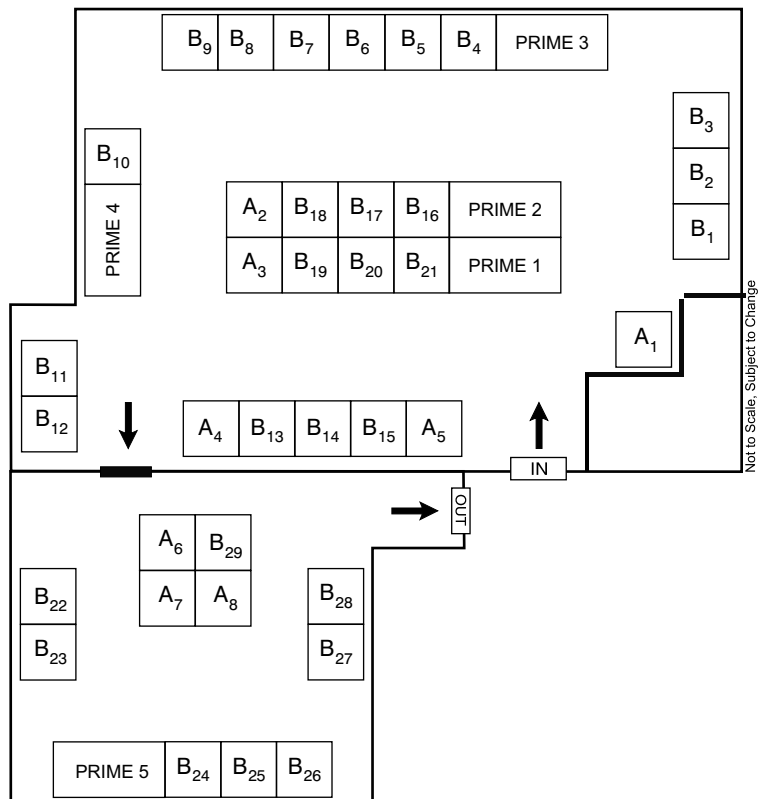

Not to Scale. Subject to Change

Floor Plans

Patna

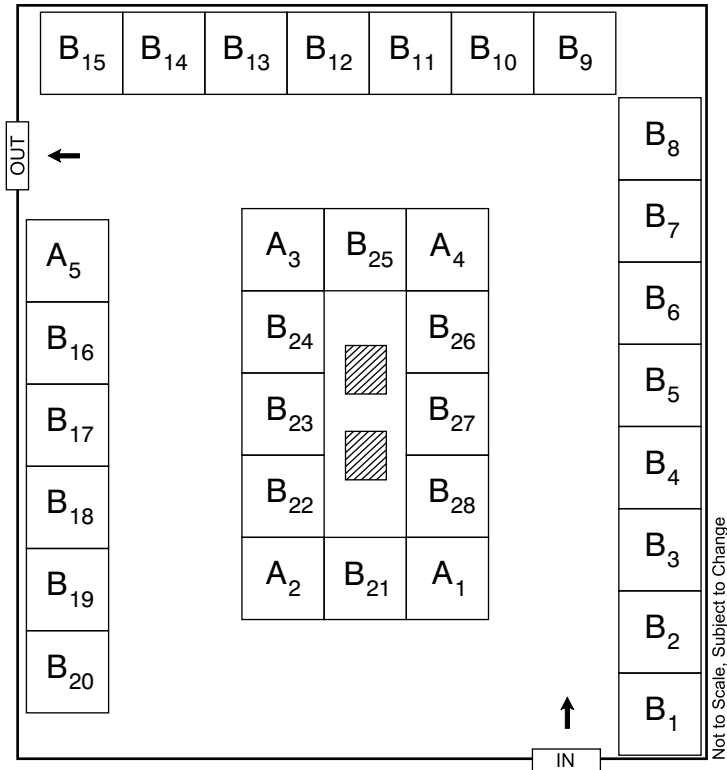

PATNA	
13 - 14 June 2009 (Sat - Sun)	
Hotel Chanakya	

Stall Type	Stall Size	Rate (INR)
A (2 sides open)	2 m x 2 m	60,000
B (1 side open)	2 m x 2 m	50,000

Additional 12.36% service tax would be applicable on the above mentioned rates.

Raipur

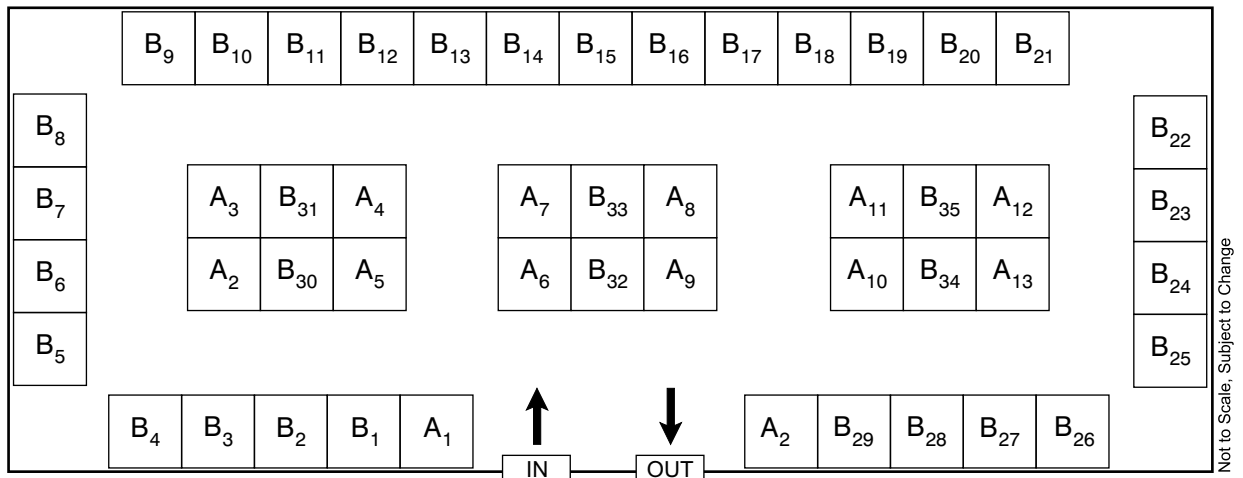

RAIPUR	
20 & 21 June 2009 (Sat & Sun)	
Hotel Babylon Intl	

Stall Type	Stall Size	Rate (INR)
A (2 sides open)	2 m x 2 m	60,000
B (1 side open)	2 m x 2 m	50,000

Additional 12.36% service tax would be applicable on the above mentioned rates.

With each stall comes a PARTICIPATION PACKAGE which consists of the following:
 • Standard Pre-Fabricated shell • Display panel walls on 2/3 sides • Name board fascia • 1 Table and 2 chairs • 3 spotlights • 2 lunch coupons per stall

Stall Booking Contract Form

Institution Details

» Contact Person

» Position or job title

» Institution name

» Address

City	Pin code
------	----------

» Phone

» Cell

» Fax

» Email

» Website

» Affiliation

» Name board Fascia to be written on Stall

» Signature & Seal

	Date
--	------

To
AFAIRS Exhibitions & Media Pvt. Ltd.
33, Dr. Sundari Mohan Avenue
Kolkata - 700 014

Dear Sir,

We have read the "Terms and Conditions" set out overleaf and accept them and would like to book space at the following cities

» **Kolkata** (06 - 08 June '09, Ice Skating Rink)

Stall No.	Size	Amount (INR)

» **Ranchi** (10 - 11 June '09, Hotel Capitol Hill)

Stall No.	Size	Amount (INR)

» **Patna** (13 - 14 June '09, Hotel Chanakya)

Stall No.	Size	Amount (INR)

» **Raipur** (20 - 21 June '09, Hotel Babylon International)

Stall No.	Size	Amount (INR)

Add 12.36% Service Tax

Total Amount

We enclose our DD / Cheque No.

Dated on Bank

for Rs. in favour of **AFAIRS Exhibitions & Media Pvt. Ltd.**, payable at Kolkata towards advance and undertake to pay the **balance by one month prior to the exhibition date.**

OTHER PAYMENT OPTIONS (Please Tick)

We have transferred the Amount to your Bank account

Account Name : AFAIRS Exhibitions & Media Pvt. Ltd.

Account No. : 018705008103

Bank : ICICI Bank Ltd, Chowringhee Road Branch, Kolkata

(Photocopy of Cheque / DD is attached alongwith the deposit slip)

Wire transfer the Amount to your Bank account

Account Name : AFAIRS Exhibitions & Media Pvt. Ltd.

Account No. : 1496537

Bank : ABN Amro Bank, Camac Street Branch, Kolkata, India

Swiftcode : ABNAINBBICAL

Please Fax this form to 033 - 2286 5788

Please draw the Cheque/DD in favour of
"AFAIRS EXHIBITIONS & MEDIA PVT. LTD."

Tear here

Terms And Conditions

This booking order form will be governed by the following terms and conditions. The terms and conditions stipulated here are not negotiable unless and until specifically agreed to in writing by AFAIRS Exhibitions & Media Pvt. Ltd. Exhibitors are requested to study the terms and conditions carefully before finalizing their participation.

1. For purposes of this order the word "Organiser" will refer to AFAIRS Exhibitions & Media Pvt. Ltd. having their office at 33, Dr. Sundari Mohan Avenue, Kolkata - 700 014 and the word Exhibitor will refer to the person and/or company who has completed this stall booking contract form.
2. The booking of stall has to be made along with an advance payment of 50% by way of crossed cheque or D.D. drawn in favour of **AFAIRS EXHIBITIONS & MEDIA PVT. LTD.** Along with the Stall Booking Contract Form duly filled and signed by a competent authority. **The balance payment is to be made one month prior to the exhibition date.** Any extra charges payable towards additional services are to be paid in cash at the venue.
3. All Exhibitors are required to comply with all the provisions of Service Tax, Sales Tax Act Regulations or any Taxes and Levies as applicable by Govt. of India enforceable at the time of the Fair.
4. Exhibitors are requested to note that all floor plans shown in the brochure are tentative and the organiser reserve the right to amend the floor plan. Further, the organiser are not liable for any change in the venue or date arising from circumstances beyond their control.
5. In case of the event being cancelled or suspended in whole or in part for causes not in the Organiser control, the organiser do not accept any consequential liability in any such eventuality, Disputes are subject to Calcutta Court Jurisdiction.
6. The Exhibitors are requested to bring their own stabilizer/inverter/UPS/spike busters etc. for a stabilized supply of power to their equipments, since the organiser cannot ensure stabilised power supply.
7. The rates do not include charges for extra lighting or decoration, demonstrators or sales personnel etc, which may be arranged on specific requests.
8. Although arrangements for round-clock security will be made by the organiser, the Exhibitors will be solely responsible for the safety of their goods.
9. Exhibitors will be fully responsible for any damage done to the premises, furniture and fixtures provided to them, and will have to make payments for any such loss / damage and the decision of the organiser in this respect will be final.
10. Any damage / loss caused to goods suffered by the exhibitor owing to pilferage, fire, rain, floods, riots, strike or accident or malicious intent during transport and carriage or at the venue owing to the same or any other reasons whatsoever shall not be made good by the organiser to the concerned exhibitor.
11. Allotment of stall location will be generally on a first-come-first served basis. The organiser reserve the right to allot stall locations as per categorisation and their decision in this regard shall be final.
12. The Exhibitors cannot sublet the stalls to third parties, transfer the stalls, utilize the stalls, other than which the said stall has been contracted for.
13. Fixing of nails, screws, bolts, etc. and painting directly on display panels provided is not permitted except on taking permission from the organiser present.
14. Goods Materials/Objects which are hazardous, inflammable, banned or forbidden, or deemed inappropriate by the organiser will not be allowed in the venue.
15. Disassembly and removal of all materials will have to be done on the same day after the end of the show, material can be taken out from the Exhibition site against authorised GATE PASS only.
16. The organiser shall have a lien over the Exhibitors goods in case of his/her default in any manner.
17. Under no circumstances will money be refunded by the organiser in case of cancellations on part of the Exhibitor who has booked stalls.
18. The organiser reserve the right to cancel the stall booking any time before or during the event, by refunding the money received, at their sole discretion and without assigning any reason. In case the stall is cancelled due to misbehaviour and unethical practice by the Exhibitor, money shall not be refunded to the Exhibitor.
19. The organiser may cancel, suspend or alter dates of the exhibition owing to circumstances beyond its control. In case of change in dates and duration of the Exhibition the contractual obligation between the Exhibitor and Organiser remains unaffected. However, the organiser stand indemnified against excessive / low turnout of visitors / premature closure or suspension of the exhibition due to unavoidable circumstances. The same shall apply if the exhibition is cancelled due to riots, strike, rain, flood, earthquake or any manmade / natural disaster, including untimely demise of either exhibitor or organiser.
No Refunds will be made by the organiser in the event any situation as described above arises.
20. In case the Exhibitors does not take possession of the stalls by 2 p.m. on the opening day the organiser reserve the right to allot the stalls to others without refunding the advances made.
21. Stall booking contract will be deemed completed only after full payment is made and the organiser have accepted the booking.
22. All exhibitor will strictly abide by the rules, regulations, terms & conditions as prescribed herewith.

Career Success Guide Advertisement Form

Why you must advertise in the Career Success Guide ?

- » Multiple advantage - **one Advertisement** insures a guaranteed **reach** to your target audience at the **important cities of India**.
- » **Minimum 30,000 copies** to be distributed **FREE** along with entry tickets.
- » Highlight your presence by advertising in the Career Guide, which will have valuable information about various Career options, specialized articles from Education experts, Advertisements, etc.
- » The Career Guide will be a complete ready reckoner for students around the year and will have **immense retentive value**.
- » **Highly cost effective medium** to reach your target audience.
- » **Mechanical Specification**
 - # Print Area : **21.5 cm x 15.3 cm**
 - # B/W Ads : Laser printouts 600dpi min. (no halftone pictures)
 - # Colour Ads : Design to be given on CD or Floppy
- » Material will be accepted in CD as CorelDraw-12, Photoshop, Freehand -10, Picture format (JPG, TIF, EPS, PDF with min. of 300dpi resolution in Greyscale or CMYK).
- » **Material Deadline : 24th May 2009**

**Reach out
cost effectively
@ 55 paise per student**



You may also e-mail the artwork at: info@afairs.com

For Booking Advertisements please fill in the Advertisement Booking form below with details and send it immediately along with the Cheque / D D in favour of "**AFAIRS Exhibitions & Media Pvt. Ltd.**" payable at Kolkata.

Tear here

To
AFAIRS
33, Dr. Sundari Mohan Avenue, 2nd Floor, Kolkata - 700 014.

Please book an advertisement space in the Career Guide. The details are as follows :

OPTION	RATE	OPTION	RATE
<input type="checkbox"/> Back Cover (Colour)	Rs. 45,000/-	<input type="checkbox"/> Full Page (Colour)	Rs. 27,000/-
<input type="checkbox"/> Front Inside (Colour)	Rs. 40,000/-	<input type="checkbox"/> Full Page (B/W)	Rs. 17,000/-
<input type="checkbox"/> Back Inside Cover (Colour)	Rs. 35,000/-	* 12.36 % Service Tax will be applicable on the above rates	

Material is being sent as CD Floppy E-mail

Enclosed is our Cheque / Draft no. date

on Bank for Rs

rupees in words

Name of the organisation

Address

Phone Fax

Contact Person

Date 08

Signature & Seal